

User Manual  
使用說明書

MB877SK **SATA** MB877IK **SAS**  
Internal Screwless Hard Drive Enclosure



## 1. Package Content

包裝說明

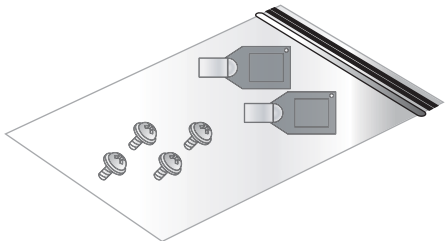
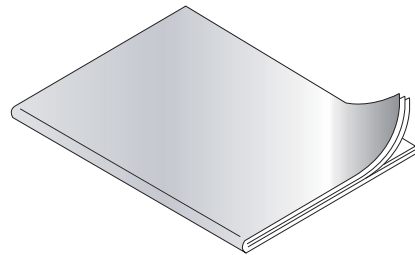
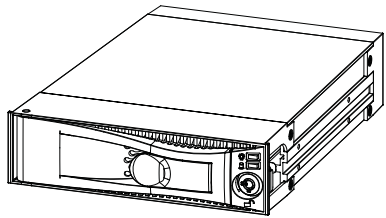

## 2. Installation Guide

硬碟安裝

2-1

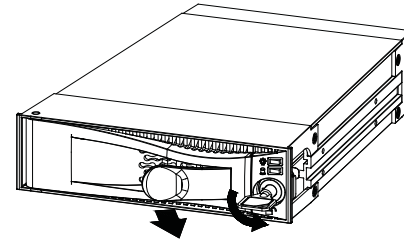

2-2

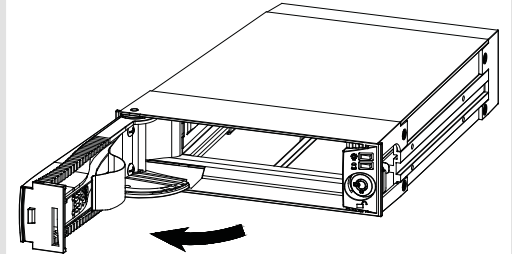

2-3

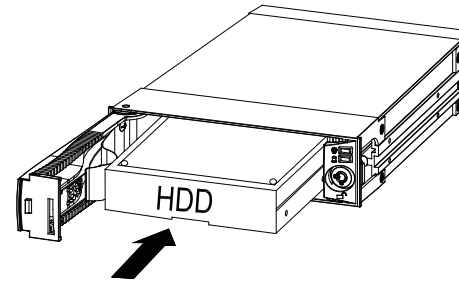

2-4

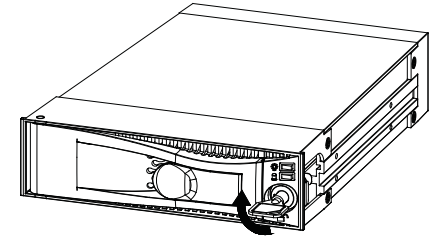

2-5

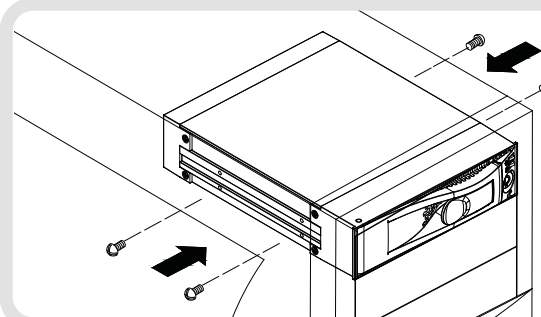

## 產品外觀

更之權利，如改版，恕不另行通知。

2. ICY DOCK will not be liable for any software, hardware and any data stored within or interfacing with our product which results in damages or dysfunctions. ICY DOCK will only be responsible for repairs and services of its own product.  
2. 如因不當使用本產品進而造成其它相關設備之故障，本公司僅負擔自屬產品之維修責任，造成其它設備毀損概不負責。

3. Due to specification differences between SATA I and SATA II hard drives, the LED will only work with SATA II hard drives. To enable the enclosure's LED with SATA I hard drives, please refer to Note 4.  
3. SATA II HDD 規格有規範HDD ACCESS 訊號，而SATA I HDD 無此規範。

4. To determine if SATA II hard drives have built-in HDD Access signal, please refer to your hard drive specifications.  
4. SATA II HDD 是否有內建HDD ACCESS 訊號功能，需參照各家硬碟製造廠設計規範。

4. To determine if SATA II hard drives have built-in HDD Access signal, please refer to your hard drive specifications.

5. Due to the difference of activity signal on SATA and SAS hard drive, when using the SATA hard drive with MB8771K the HDD Access Indicator will show differently from using SAS hard drive. When using the SATA hard drive with MB8771K (SAS Interface), the HDD Access Indicator will display:

Device powered on: HDD Access Indicator stays solid amber.

During hard drive read / write: HDD Access Indicator turn off.

5. 因SATA HDD與SAS HDD燈號定義不相同，若MB8771K(SAS介面)使用SATA HDD時，ACCESS會與使用SAS HDD顯示方式不同  
MB8771K(SAS介面)使用SATA HDD時，ACCESS顯示方式如下：

HDD通電位讀取時，Access燈恆亮

HDD讀取時Access燈熄滅

6. To perform hot-swap function, the host must also support hot-swap.

6. 若欲完全使用Hot-swap的功能則Host端也需要支援Hot-swap功能。

7. For any further inquiries related to ICY DOCK products, please visit <http://www.icydock.com>.

7. 如欲知更多產品資訊，歡迎上網瀏覽本公司網站：[www.icydock.com](http://www.icydock.com)